

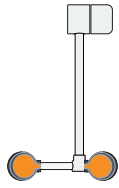

G1779 Eye/Face Wash, Deck Mounted AutoFlow™ 90° Swing-Down

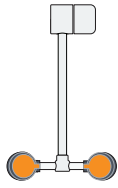

G1779LH-L



G1779LH

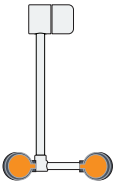

G1779LH-R

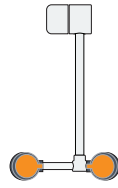

G1779L

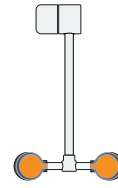

G1779

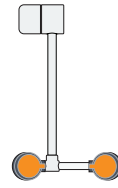

G1779R



Application: AutoFlow™ eye/face wash for mounting on counter. Spray heads swing down from storage to operational position, activating water flow. Available in a variety of spray head configurations to minimize obstructions at a sink. *Note: If unit is not installed at a sink, floor drain should be provided underneath unit to prevent accumulation of water on floor.*

Spray Head Assembly: Two FS-Plus™ spray heads. Each head has a “flip top” dust cover, internal flow control and filter to remove impurities from the water flow.

Valve: 1/2" IPS plug-type valve with PTFE coated O-ring seals. Swinging head assembly down from storage to operational position opens orifice and activates water flow. Unit remains in operation until spray head assembly is returned to storage position.

Strainer: Unit is furnished with in-line strainer to protect valve and spray heads from debris in water line.

Mounting: Valve is installed in chrome plated brass housing. Unit mounts on countertop behind sink. Furnished with mounting hardware for securing unit to counter.

Construction: Polished chrome plated brass.

Supply: 1/2" NPT female inlet.

Sign: ANSI-compliant identification sign.

Quality Assurance: Unit is completely assembled and water tested prior to shipment.

Available Options

- G6020** Thermostatic mixing valve precisely blends hot and cold water to deliver tepid water as required by ANSI Z358.1-2014. Refer to “Tempering Valves” section for complete technical and product selection information.





□ G1779 Eye/Face Wash, Deck Mounted AutoFlow™ 90° Swing-Down

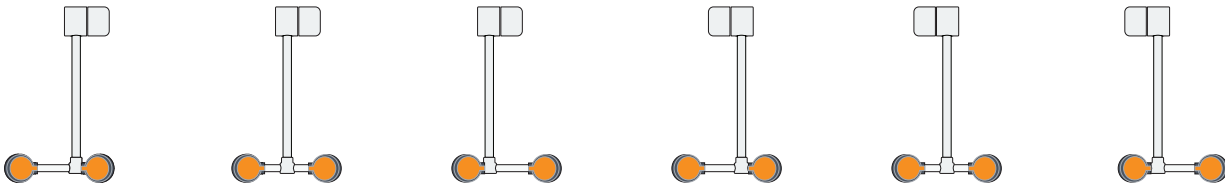

□ G1779LH-L

□ G1779LH

□ G1779LH-R

□ G1779L

□ G1779

□ G1779R

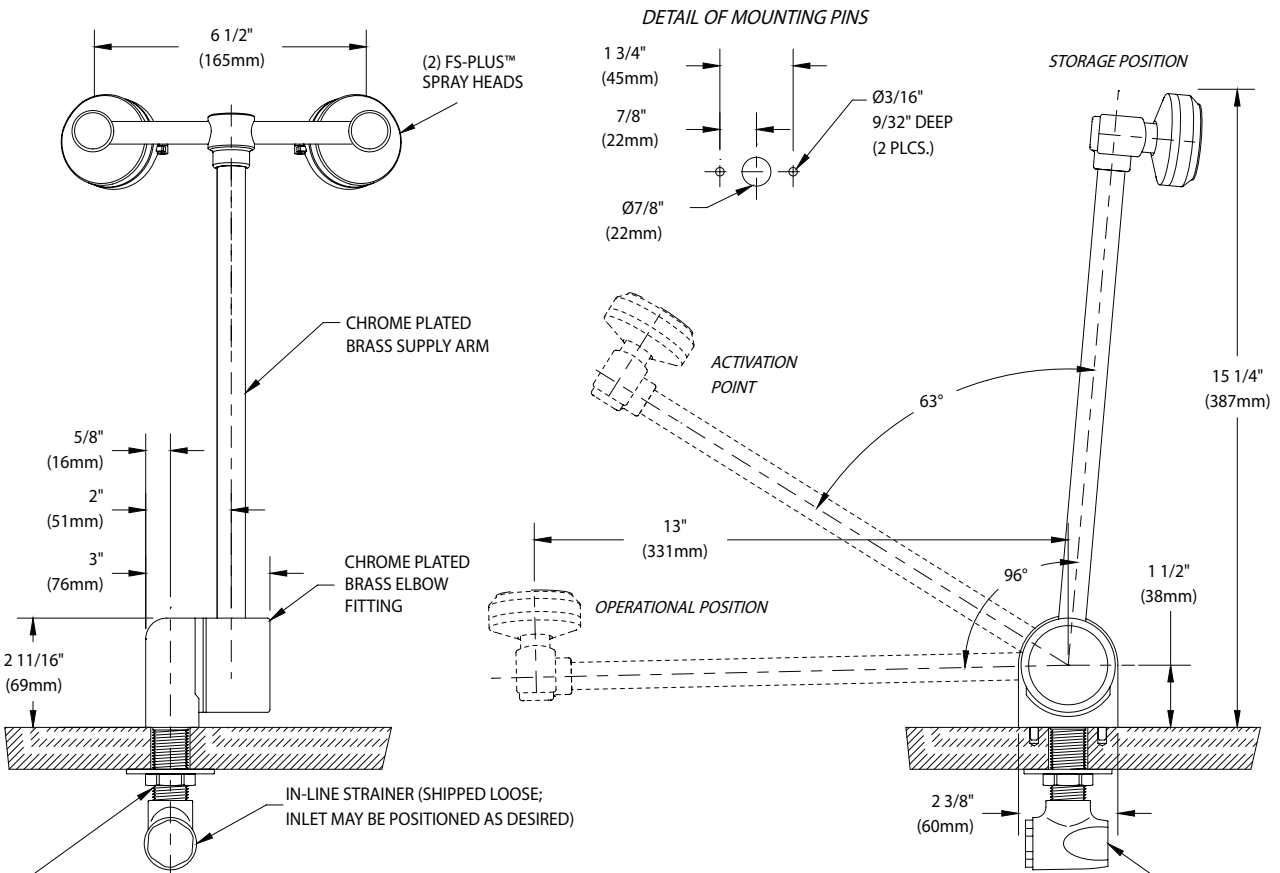

NOTES:

1. SWINGING OUTLET HEAD ASSEMBLY DOWN 96 DEGREES FROM VERTICAL TO HORIZONTAL POSITION ACTIVATES WATER FLOW.
2. EACH FS-PLUS™ SPRAY HEAD HAS A "FLIP-TOP" DUST COVER, INTERNAL FLOW CONTROL AND FILTER TO REMOVE IMPURITIES FROM THE WATER FLOW.
3. UNIT MOUNTS INTO COUNTERTOPS UP TO 1 1/2" THICK. BASE OF UNIT HAS PINS TO PREVENT UNIT FROM TURNING ON COUNTER.
4. UNIT IS FURNISHED WITH IN-LINE STRAINER TO PROTECT SPRAY HEADS AND VALVE COMPONENTS FROM DEBRIS IN WATER LINE.
5. VALVE BEGINS TO OPEN AT "ACTIVATION POINT" SHOWN ABOVE.

1/2" IPS MOUNTING SHANK WITH LOCKNUT AND WASHER

THIS SPACE FOR ARCHITECT/ENGINEER APPROVAL

Distributed by:
Safety Emporium
 PO Box 1003
 Blackwood, NJ 08012
 Ph: (866) 326-5412 toll-free
 Fax: (856) 553-6154
 esupport@safetyemporium.com
 www.safetyemporium.com

Sign Included



Due to continuing product improvement, the information contained in this document is subject to change without notice. All dimensions are ± 1/4" (6mm). rev. 0817

Guardian Equipment 312 447 8100 TELEPHONE
 1140 N North Branch St 312 447 8101 FACSIMILE
 Chicago, IL 60642 gesafety.com

Listed 8116. Units have been tested to and comply with ANSI Z358.1-2014 and the Uniform Plumbing Code.

